

Dimension 200 x 200 to 2200 x 2200

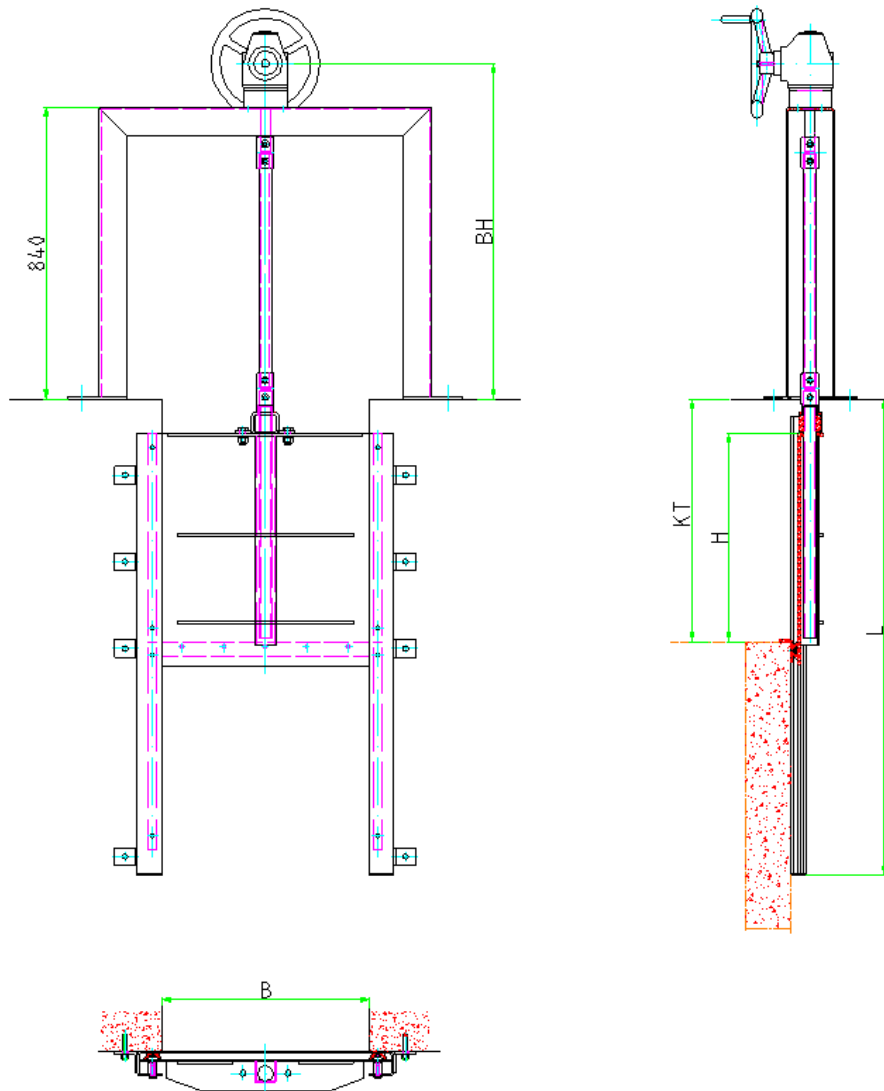

Design: TESACO, acc. to DIN 19569-4, BS 7775:2005, ANSI/AWWA C561-04, 3-face sealing

Material: The following standard material combinations are available:

Type: A4 - Frame and door fabricated from S.S. 316
 Type: A2 - Frame and door fabricated from S.S. 304

Sealing made from waste water resistant rubber neoprene
 Sliding bars made from plastic PE
 Spindle nut made of zinc-free bronze
 Spindle made from S.S. 316
 Fastening elements made from S.S.316

Corrosion protection: Stainless steel pickled and passivated